

# Raspberry Pi Projekte

#glt17



# Inhalt

---

- Home Automation
  - Sensorik
- Raspberry Pi Zero
  - Ressourcen
- Andere Projekte

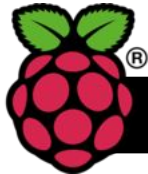

# Raspberry Pi Home Automation

---

- Anwendungsgebiete
  - Fernsteuerung von
    - Steckdosen
    - Rolläden & Jalousien
  - Zeitsteuerung von Licht & Heizung
  - Zugangskontrolle / Alarmanlage
  - Mediacenter / Infodisplay
  - ... sonstiges ...

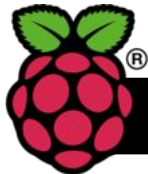

# Raspberry Pi Home Automation

- alertR
- fhem
- pihome
- openhomeautomation
- heimcontrol
- pidome,....

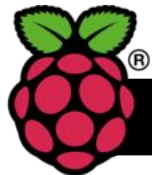
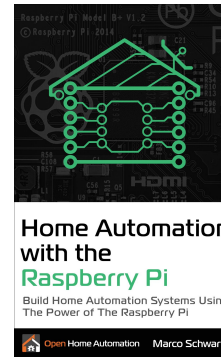
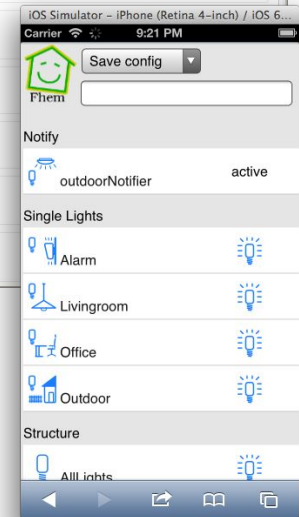
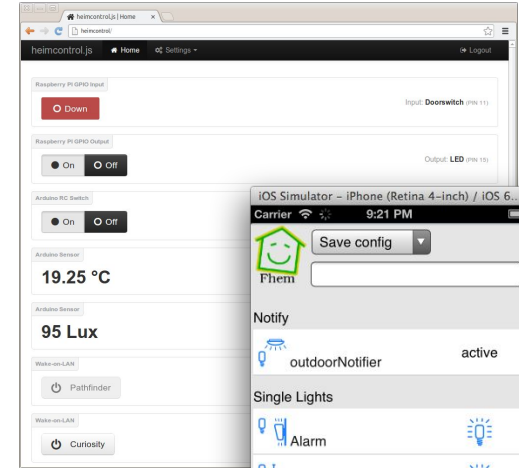
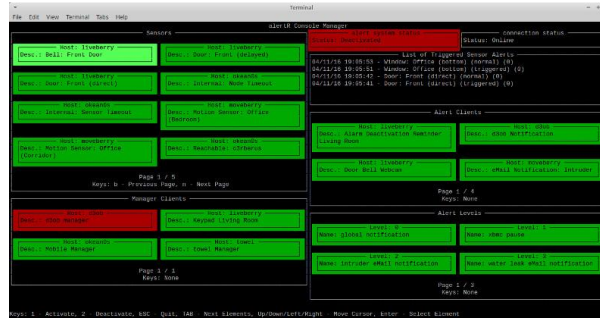

# Sensorik

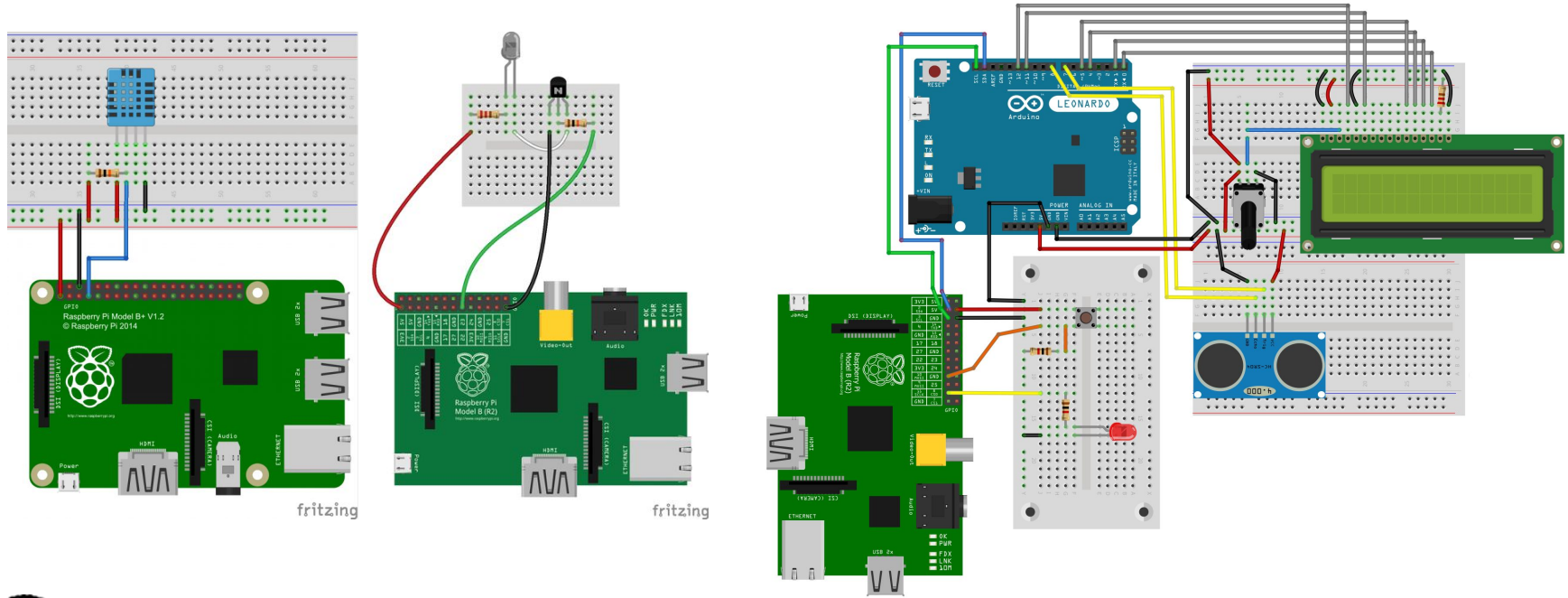

# Raspberry Pi Zero

---

- <https://www.hackster.io/raspberry-pi/products/raspberry-pi-zero>
- <https://hackaday.com/tag/raspberry-pi-zero/>
- <https://beebom.com/best-raspberry-pi-zero-projects/>
- <http://www.thingiverse.com/glitchpudding/collections/pi-zero>

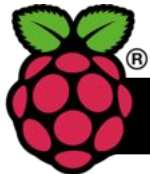

# Beispiele & Ressourcen

- <http://fritzing.org/projects/by-tag/raspberry%20pi/>

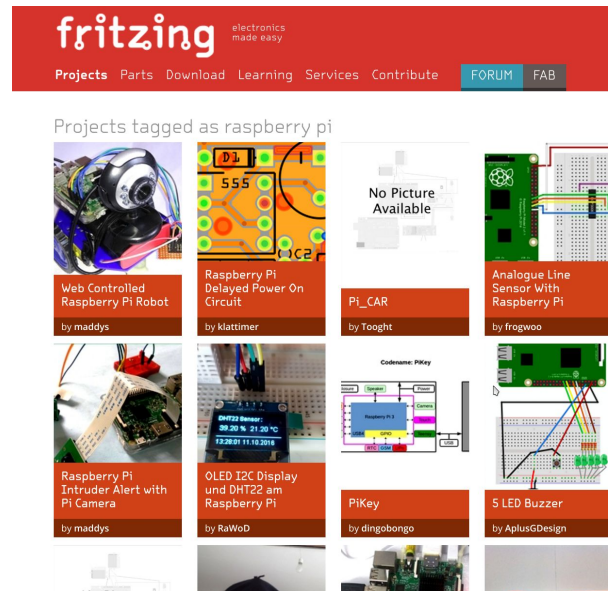

The screenshot shows the Fritzing website interface. At the top, the logo "fritzing" is displayed with the tagline "electronics made easy". Below the logo, there are navigation links: "Projects", "Parts", "Download", "Learning", "Services", "Contribute", "FORUM", and "FAB". The main content area is titled "Projects tagged as raspberry pi" and displays a grid of project thumbnails. Each thumbnail includes a small image, a title, and the author's name. The projects shown are:

- Web Controlled Raspberry Pi Robot by maddys
- Raspberry Pi Delayed Power On Circuit by Mattimer
- No Picture Available by Tooght
- Analogue Line Sensor With Raspberry Pi by frogwoo
- Raspberry Pi Intruder Alert with Pi Camera by maddys
- OLED I2C Display und DHT22 am Raspberry Pi by RaWoD
- PI\_CAR by Tooght
- PIKey by dingobongo
- 5 LED Buzzer by AplusGDesign



# Raspberry als Thin-Client

---

- PTS - Wildon
  - 16 Terminals (RPI Model B+ & 3)
    - berryterminal
  - 1 LTSP-Server
    - Debian
      - XEN
        - Edubuntu





# BrickPi - RPi & Lego

- <http://www.dexterindustries.com/BrickPi/>
- <https://github.com/DexterInd/BrickPi>

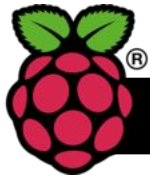
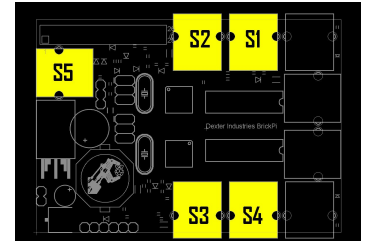
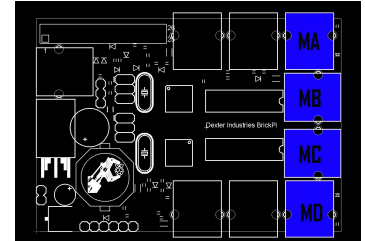
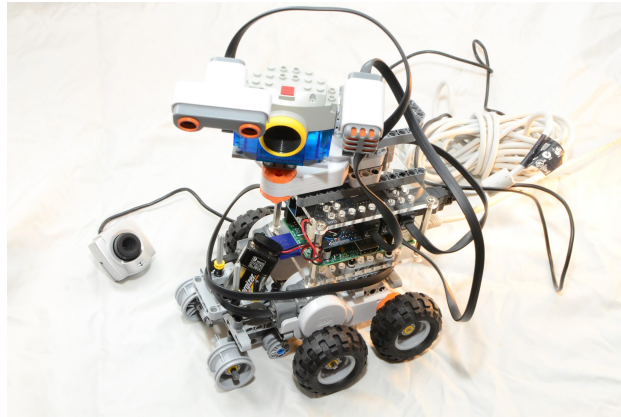
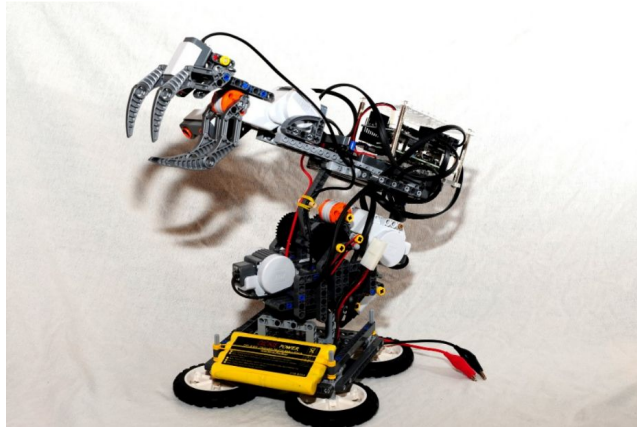

# Sonst noch...

- Multimedia-Center (Kodi)
- Werbeblocker (Pi-hole)
- Spielekonsole (RetroPie)
- WebRadioPlayer (Pi MusicBox)
- The Drone Pi
- MiniPC
- Printserver
- ... :)

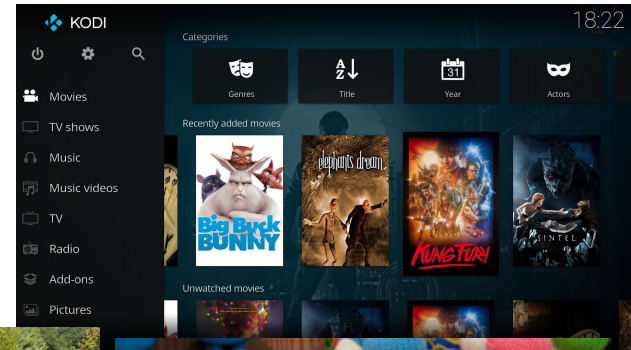

(<http://www.schnatterente.net/technik/was-man-alles-mit-einem-raspberry-pi-machen-kann> - 75 Beispiele)

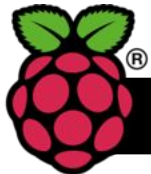

# Aktuelle Projekte

---

- Home Automation / 'Fresh Air Notifier'
- Internet Connectivity Monitoring
- Feuerwehr Alarm-Mail Anzeige & Drucker
- PhotoBox

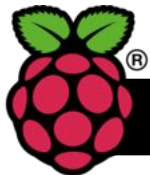

Danke für Ihre Aufmerksamkeit!

Viel Spaß bei #glt17

~ Besucht uns beim Projektstand 'Einplatinencomputer'!

Twitter: @schusterfredl | @m\_stroh

Web: mwallner.net | strohmayers.com

